



# CATÁLOGO PERFIS

*A força inovadora do aço.*

**ANANDA**



# PERFIS ANANDA METAIS: SUSTENTAM O PROGRESSO



# PERFIL DRYWALL

Os Perfis Drywall da Ananda Metais são produzidos com a mais alta tecnologia e o mais rigoroso controle de qualidade, desde o recebimento da bobina, corte, conformação, pintura, embalagem e expedição do produto, com excelente qualidade, preços muito competitivos e incomparáveis prazos de entrega.

Em total conformidade com a Norma Brasileira - NBR 15.217 - estabelecida pela ABNT, os Perfis Drywall da Ananda Metais saem da fábrica com identificação da marca, espessura do aço, tipo de perfil, comprimento da peça, data de fabricação, especificações da máquina e ferramental utilizado no processo; dados que permitem a rastreabilidade e a qualidade do produto.

Ideal para a construção e a reforma de interiores, o sistema de paredes em drywall é desenvolvido com tecnologia moderna e sustentável. Disponibilidade de pintura eletrostática para qualquer perfil.



## MONTANTE DE 48

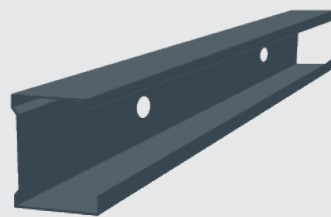
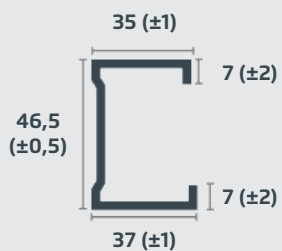

## MONTANTE DE 70

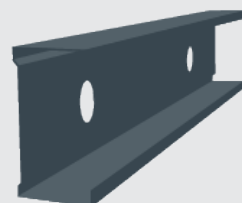
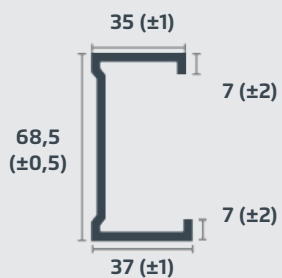

## MONTANTE DE 70 PARA FIXAÇÃO DE BATENTE (CHAPA 0,95 mm)

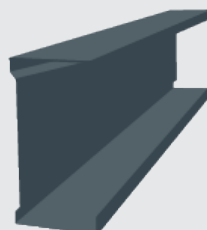
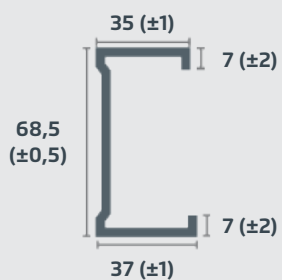

## MONTANTE DE 75

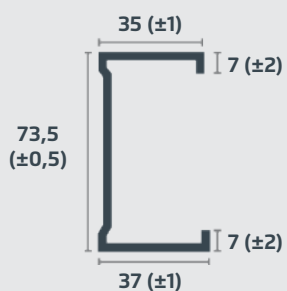

## MONTANTE DE 90

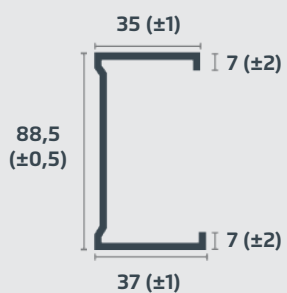

## GUIA DE 48/70/75/90

48 - 48 (+/- 0,5)  
70 - 70 (+/- 0,5)  
75 - 75 (+/- 0,5)  
90 - 90 (+/- 0,5)

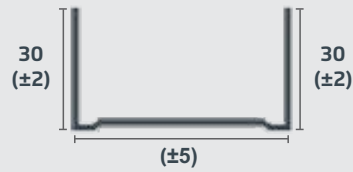

## GUIA COM ABA PARA MONTANTE 48/70/75/90

48 - 48 (+/- 1,0)  
70 - 70 (+/- 1,0)  
75 - 75 (+/- 1,0)



## CANTONEIRA DE PROTEÇÃO PERFURADA 23x23

(CHAPA 0,43 mm)

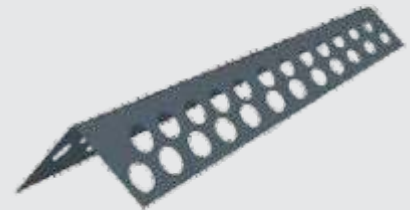
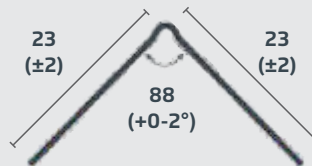

## CANTONEIRA DE PROTEÇÃO PERFURADA 32x32

(CHAPA 0,43 mm)

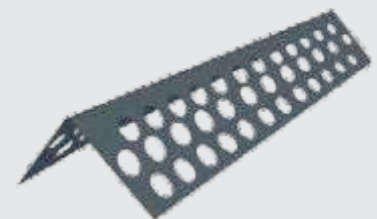
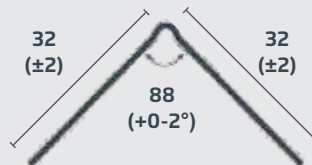

## CANTONEIRA DE FORRO 13x30

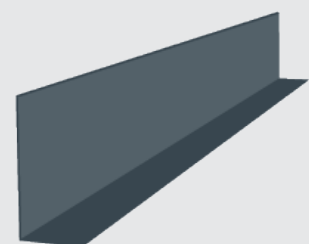

## CANTONEIRA DE FORRO 25x30

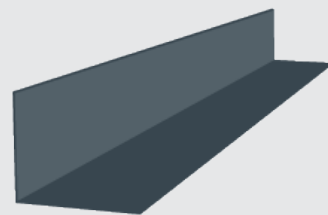
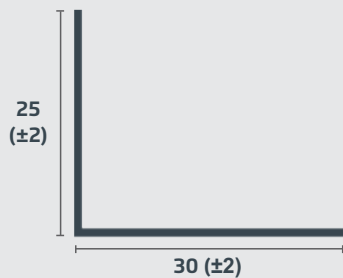

## CANTONEIRA DE FORRO AMASSADA

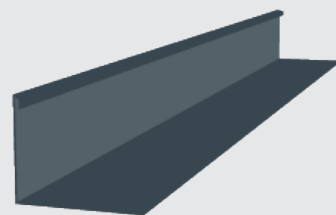
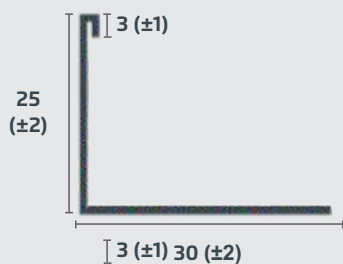

## TABICA 40x48 LISA OU PERFURADA

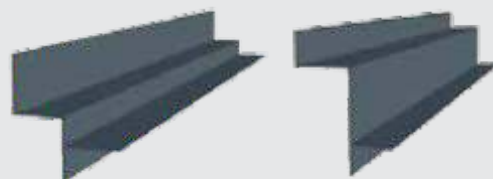
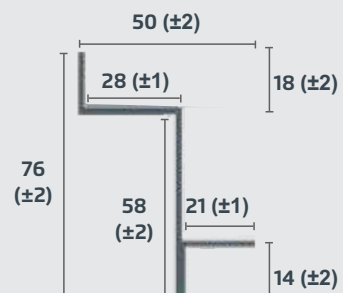

## TABICA 40x48 PRÉ E PÓS-PINTADA

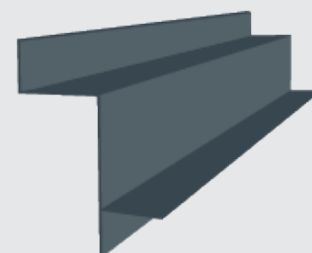
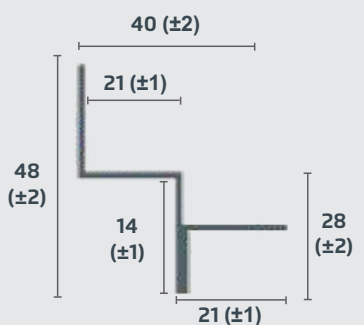

## TABICA 76x50 PERFURADA

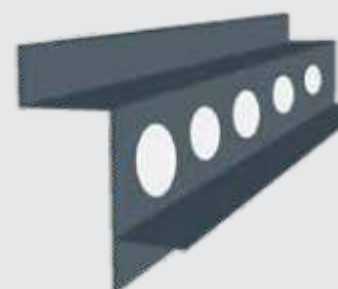
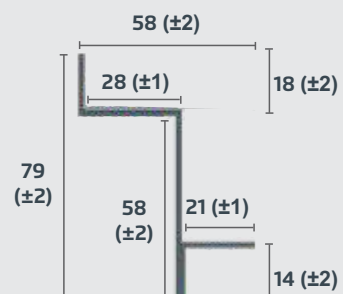

## PERFIL PARA FORRO CANALETA 70x20

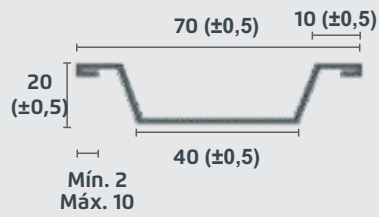

## PERFIL PARA FORRO F530

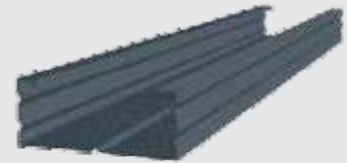
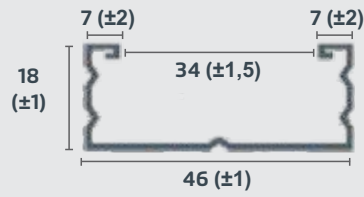

## RODA TETO U 20x30

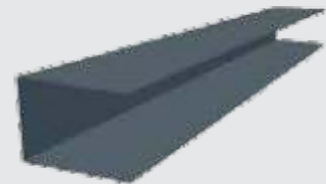
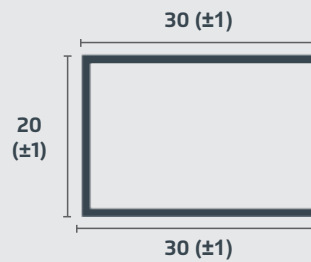

## RODA TETO U 30x30

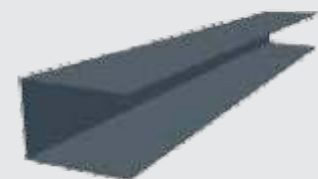
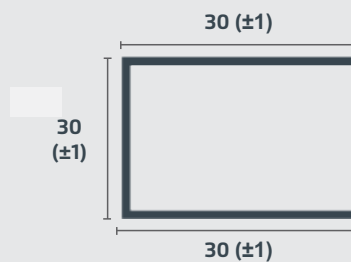

## RODAPÉ DE IMPERMEABILIZAÇÃO

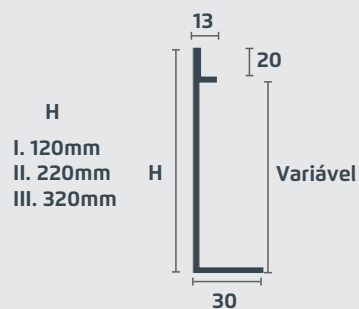



# PERFIS ESPECIAIS

A Ananda Metais desenvolve perfis especiais de acordo com a necessidade específica de cada projeto e cliente, com o objetivo de aumentar a performance dos sistemas drywall, sempre em conformidade com a Norma Brasileira – NBR 15.217, o que garante o desempenho e a qualidade dos produtos. Consulte-nos. Disponibilidade de pintura eletrostática para qualquer perfil.

## MONTANTES COM MEDIDAS ESPECIAIS

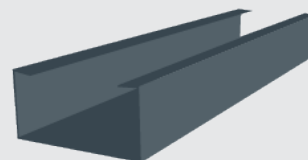
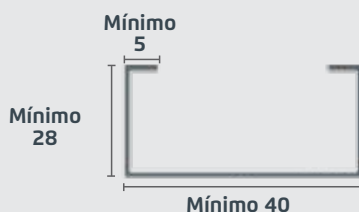

## GUIAS COM MEDIDAS ESPECIAIS

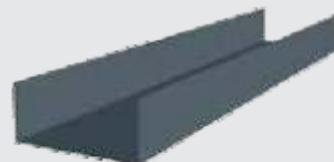

## TABICAS ESPECIAIS COM E SEM PINTURA

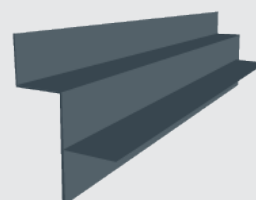
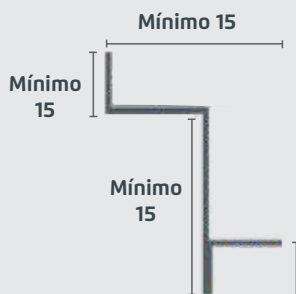



# ACESSÓRIOS PARA DRYWALL

PEÇAS  
GRAVADAS PARA  
IDENTIFICAÇÃO

Com ampla linha de acessórios, a Ananda Metais oferece soluções completas para uma montagem perfeita dos sistemas drywall.

Os acessórios são produzidos de acordo com as normas de qualidade vigentes exigidas no mercado de atuação.



EMENDA  
F530



PENDURAL  
F530



PENDURAL  
MONTANTE



PENDURAL  
ANÃO F530



JUNÇÃO H

# ACESSÓRIOS FORRO PVC

A Ananda Metais produz todos os acessórios necessários para a montagem estrutural de forro de PVC. Com qualidade e tecnologia incomparáveis, garantem limpeza, praticidade e excelente acabamento na execução do forro. Os perfis de aço galvanizado com nervuras oferecem o enrijecimento, e os pendurais agilizam a obra, resultando em um perfeito alinhamento do forro.

TIRANTE  
E TIRANTE  
COM ELO



PERFIL  
PVC 20X15

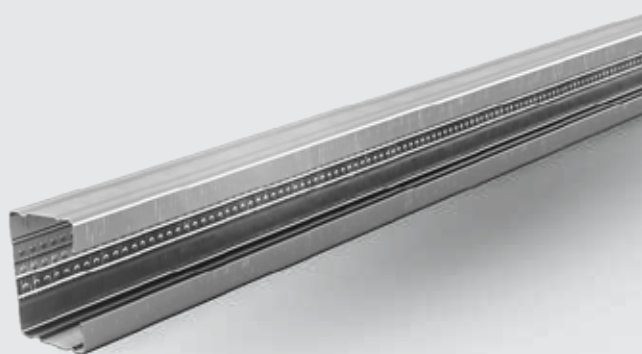

medidas em mm

# ALÇAPÃO

Os Alçapões Ananda são dispositivos desenvolvidos para possibilitar acesso fácil e rápido ao forro de drywall. Além de garantir agilidade na instalação, possuem travas de segurança contra queda e podem ser abertos com um simples clique. São feitos em alumínio ou em aço com pintura eletrostática branca e estão disponíveis nas seguintes medidas:

A x B

- 200 x 200 mm
- 300 x 300 mm
- 400 x 400 mm
- 500 x 500 mm
- 600 x 600 mm

Outras medidas sob consulta.

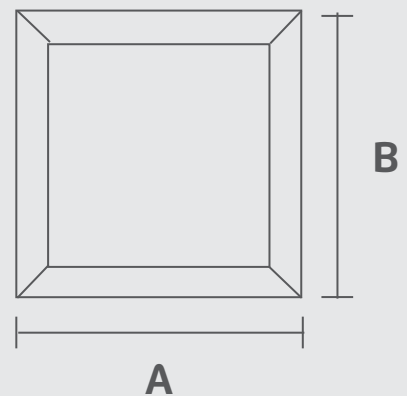

# CHAPAS DE REFORÇO

A Chapa de Reforço Ananda é utilizada quando se faz necessária a fixação de objetos mais pesados na parede de drywall. A chapa é fixada entre dois montantes sob a placa de gesso e aumenta a resistência do sistema. Exemplo de objetos: televisores, armários e prateleiras.

**APLICAÇÃO  
400 mm**

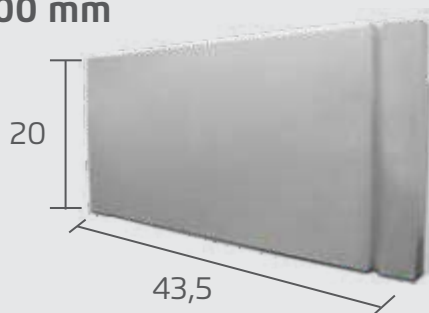

**APLICAÇÃO  
600 mm**



Medidas em mm



# PERFIL STEEL FRAME

O Perfil Steel Frame é um perfil de aço galvanizado, utilizado como estrutura em obras de pequeno e grande portes, substituindo a alvenaria comum. Os perfis Ananda são produzidos em aço galvanizado de acordo com o Sistema Métrico Internacional e conforme exigência da norma ABNT 15.253.

Saem da fábrica com identificação da marca, espessura do aço, tipo de perfil, comprimento da peça, data de fabricação, especificações da máquina e ferramental utilizado no processo; dados que permitem a rastreabilidade e a qualidade do produto.

Com fabricação verticalizada, a Ananda Metais assegura confiabilidade, preços competitivos, prazo de entrega e qualidade do produto. O sistema de construção a seco possibilita a execução de uma obra sustentável com excelente qualidade, construída com agilidade, segurança e excelência no conforto térmico e acústico.

## MONTANTE DE 90 ESTRUTURAL

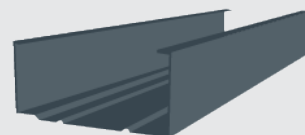
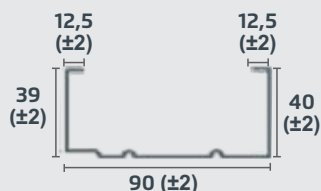

## MONTANTE DE 140 ESTRUTURAL

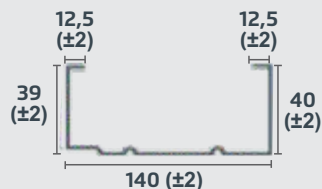

## MONTANTE DE 200 ESTRUTURAL

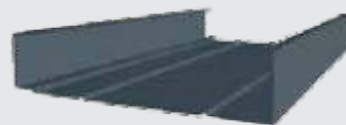
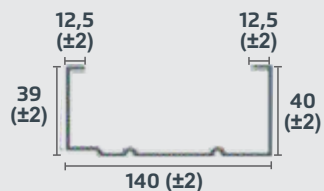

## GUIA DE 90 ESTRUTURAL

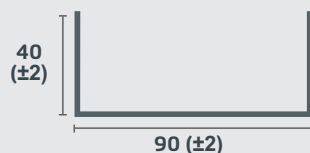

## GUIA DE 140 ESTRUTURAL

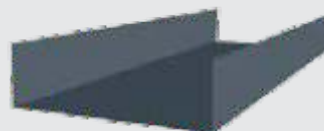
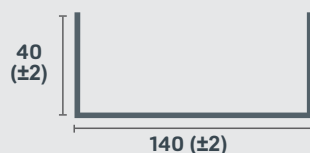

## GUIA DE 200 ESTRUTURAL



## RIPA METÁLICA

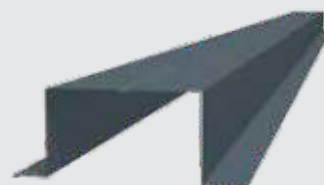
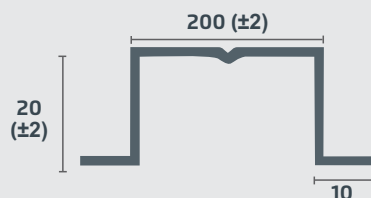

## CARTOLA PARA PLACA CIMENTÍCIA

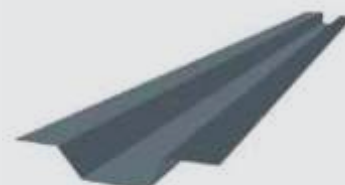
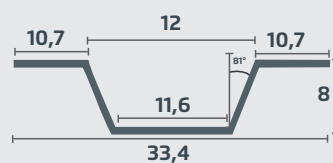

# PERFIL CLICADO TOPCLICK



O TopClick Ananda é o perfil para forros removíveis, fabricado em aço galvanizado pré-pintado. Graças ao sistema de encaixe clicado, o TopClick Ananda é muito fácil de instalar e faz com que o alinhamento e o acabamento das placas fiquem perfeitos, com máxima segurança e precisão. É um produto que oferece ótimo custo-benefício e pode ser encontrado nas seguintes versões:

## MODULAÇÃO 1.250



MODELOS DISPONÍVEIS	CORES	CARGA/M <sup>2</sup>
Linha T24	Branco	8,07
Linha T24	Preto	8,07
Linha T15	Branco	6,0

## MODULAÇÃO 625

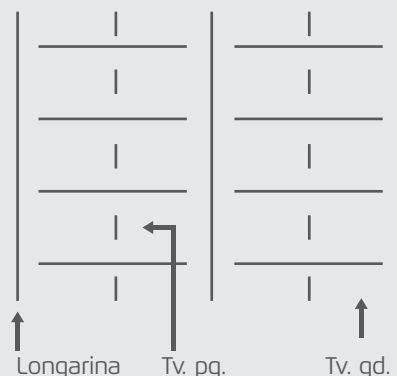

MODULAÇÃO	COMPRIMENTO	USO POR (PÇ/M <sup>2</sup> )
Longarina	3.750	0,21
Travessa Grande	1.250	1,28
Travessa Pequena	625	1,28
Cantoneira	3.000	0,20

**LINHA T15** inha  
para 6,00 kg/m<sup>2</sup>

## PRINCIPAL

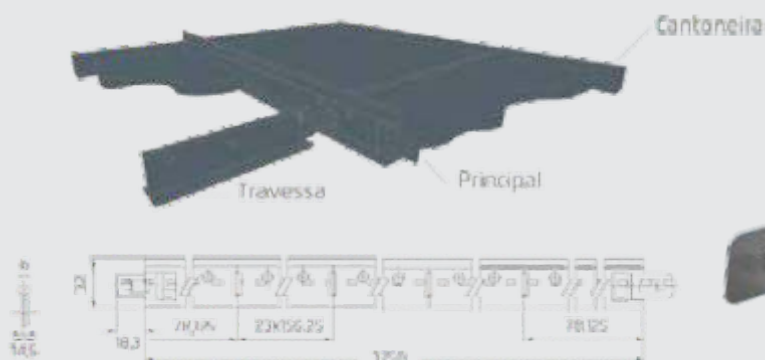

L	Comprimento	Altura	Largura	Peças/caixa	Peso/caixa
T15	3.750 mm	32 mm	14,5 mm	25	19,28 kg

## TRAVESSA

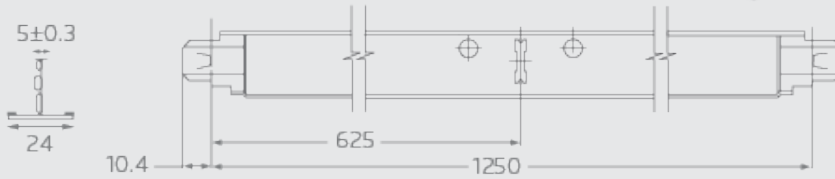

Linha	Comprimento	Altura	Largura	Peças/caixa	Peso/caixa
T15	1250 mm	32 mm	14,5 mm	50	19,5 kg
T15	0,625 mm	32 mm	14,5 mm	75	14,85 kg

## CANTONEIRA

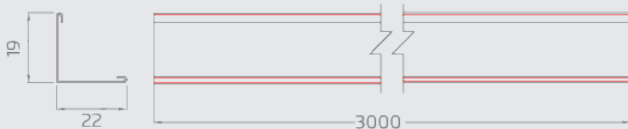

Linha	Comprimento	Altura	Largura	Peças/caixa	Peso/caixa
143	3000 mm	19 mm	22 mm	40	26,5 kg

## LINHA 1900 - T24

para 8,07 kg/m<sup>2</sup>

inha

## PRINCIPAL

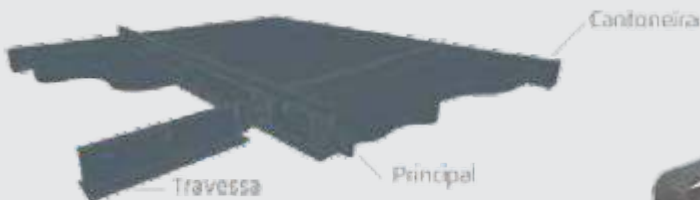

L	Comprimento	Altura	Largura	Peças/caixa	Peso/caixa
T1900	3750 mm	32 mm	24 mm	25	23 kg

## TRAVESSA

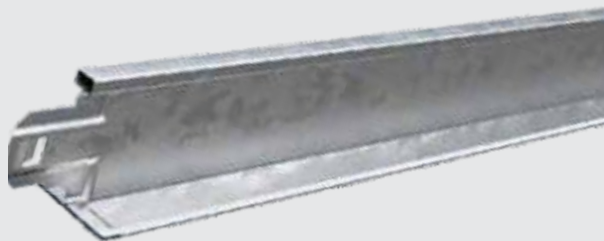

Linha	Comprimento	Altura	Largura	Peças/caixa	Peso/caixa
1900	1250 mm	24 mm	24 mm	50	12,8 kg
1900	0,625 mm	24 mm	24 mm	75	10 kg

## CANTONEIRA



Linha	Comprimento	Altura	Largura	Peças/caixa	Peso/caixa
143	3000 mm	19 mm	22 mm	40	16,5 kg

# ACESSÓRIOS PENDURAIIS TOPCLICK



Os acessórios TopClick desempenham importante papel na instalação de forros removíveis, pois auxiliam no alinhamento e na sustentação das placas. Os pendurais devem ser fixados a uma distância de até 1.200 mm entre eles no perfil principal.

### PENDURAL LINHA 1900



### PENDURAL REBITE



## PIRACICABA

R. Antônio Graneiro Lopes Filho, 205  
Distrito Industrial Uninorte  
19 2106.9050

anandametais.com.br

19 21069050

## TRÊS LAGOAS

Av. Ranulpho Marques Leal, 2.464  
Jardim Alvorada  
67 2105.5450

## CUIABÁ

Av. H, 625 - Quadra Ind. 1/4  
Distrito Industrial  
65 3667.1692

A Ananda se reserva o direito de alterar quaisquer informações contidas no catálogo, bem como tirar produtos da linha sem aviso prévio. Imagens ilustrativas.

*A força inovadora do aço.*

**ANANDA**